

High Efficiency Blue LED, \varnothing 3 mm Tinted Non-Diffused Package

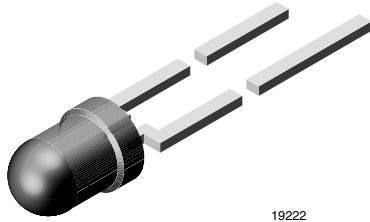

DESCRIPTION

This device has been redesigned in 1998 replacing SiC by GaN technology to meet the increasing demand for high efficiency blue LEDs.

It is housed in a 3 mm tinted non-diffused plastic package.

All packing units are categorized in luminous intensity groups. That allows users to assemble LEDs with uniform appearance.

FEATURES

- GaN on SiC technology
- Standard \varnothing 3 mm (T-1) package
- Small mechanical tolerances
- Medium viewing angle
- Very high intensity
- Luminous intensity categorized
- ESD class 1
- Lead (Pb)-free device

APPLICATIONS

- Status lights
- OFF/ON indicator
- Background illumination
- Readout lights
- Maintenance lights
- Legend light

PRODUCT GROUP AND PACKAGE DATA

- Product group: LED
- Package: 3 mm
- Product series: standard
- Angle of half intensity: $\pm 22^\circ$

PARTS TABLE		
PART	COLOR, LUMINOUS INTENSITY	TECHNOLOGY
TLHB4200	Blue, $I_V > 25$ mcd	GaN on SiC
TLHB4201	Blue, $I_V = (40 \text{ to } 132)$ mcd	GaN on SiC

ABSOLUTE MAXIMUM RATINGS ¹⁾ TLHB420.				
PARAMETER	TEST CONDITION	SYMBOL	VALUE	UNIT
Reverse voltage		V_R	5	V
DC Forward current	$T_{amb} \leq 60^\circ\text{C}$	I_F	20	mA
Surge forward current	$t_p \leq 10 \mu\text{s}$	I_{FSM}	0.1	A
Power dissipation	$T_{amb} \leq 60^\circ\text{C}$	P_V	100	mW
Junction temperature		T_j	100	$^\circ\text{C}$
Operating temperature range		T_{amb}	- 40 to + 100	$^\circ\text{C}$
Storage temperature range		T_{stg}	- 40 to + 100	$^\circ\text{C}$
Soldering temperature	$t \leq 5$ s, 2 mm from body	T_{sd}	260	$^\circ\text{C}$
Thermal resistance junction/ambient		R_{thJA}	400	K/W

Note:

¹⁾ $T_{amb} = 25^\circ\text{C}$, unless otherwise specified

OPTICAL AND ELECTRICAL CHARACTERISTICS ¹⁾ BLUE							
PARAMETER	TEST CONDITION	PART	SYMBOL	MIN	TYP.	MAX	UNIT
Luminous intensity ²⁾	$I_F = 20 \text{ mA}$	TLHB4200	I_V	25	50		mcd
		TLHB4201	I_V	40		132	mcd
Dominant wavelength	$I_F = 10 \text{ mA}$		λ_d		466		nm
Peak wavelength	$I_F = 10 \text{ mA}$		λ_p		428		nm
Angle of half intensity	$I_F = 10 \text{ mA}$		ϕ		± 22		deg
Forward voltage	$I_F = 20 \text{ mA}$		V_F		3.9	4.5	V
Reverse voltage	$I_R = 10 \mu\text{A}$		V_R	5			V

Note:

1) $T_{amb} = 25 \text{ }^\circ\text{C}$, unless otherwise specified

2) in one packing unit $I_{Vmin}/I_{Vmax} \leq 0.5$

TYPICAL CHARACTERISTICS

$T_{amb} = 25 \text{ }^\circ\text{C}$, unless otherwise specified

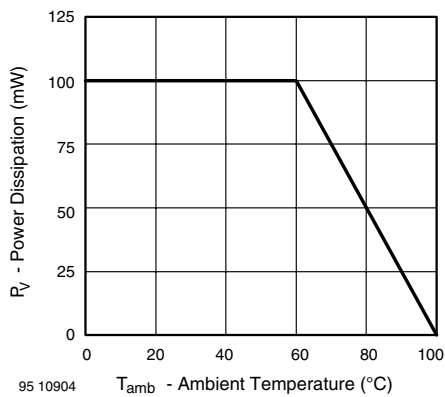

Figure 1. Power Dissipation vs. Ambient Temperature

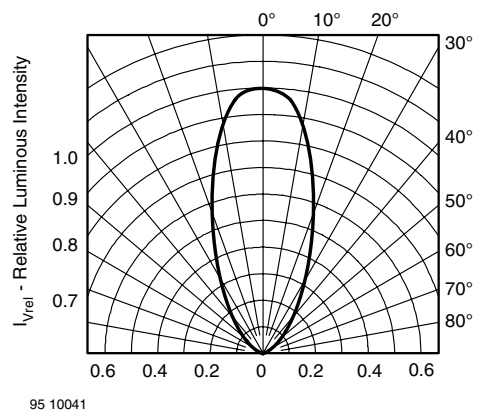

Figure 3. Rel. Luminous Intensity vs. Angular Displacement

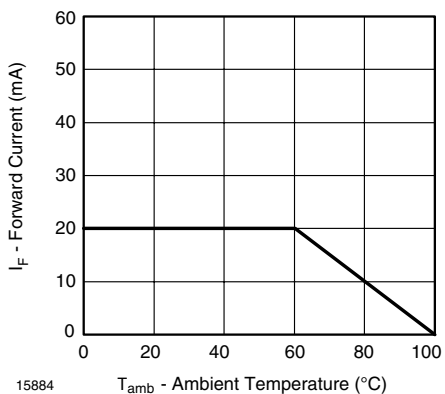

Figure 2. Forward Current vs. Ambient Temperature for InGaN

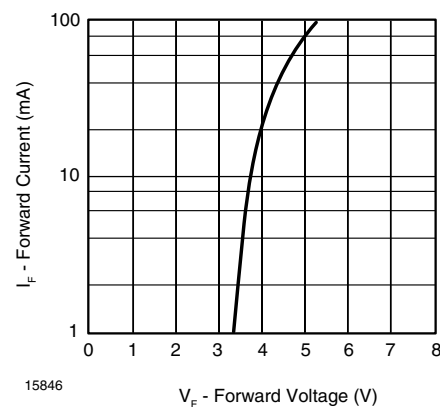

Figure 4. Forward Current vs. Forward Voltage

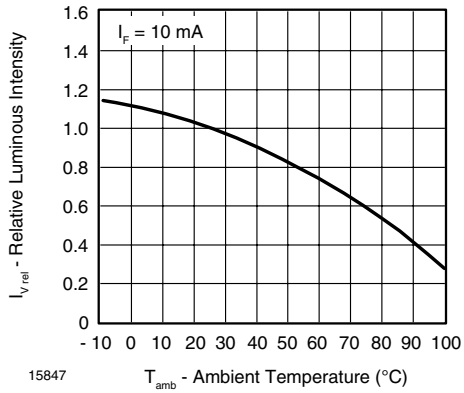

Figure 5. Rel. Luminous Flux vs. Ambient Temperature

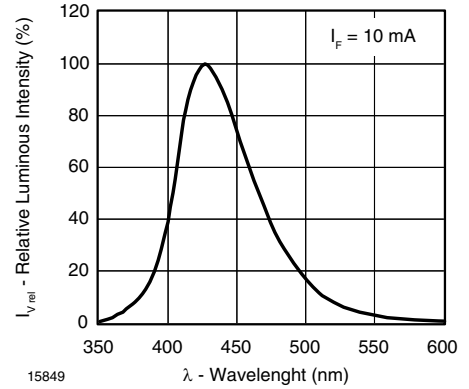

Figure 7. Relative Intensity vs. Wavelength

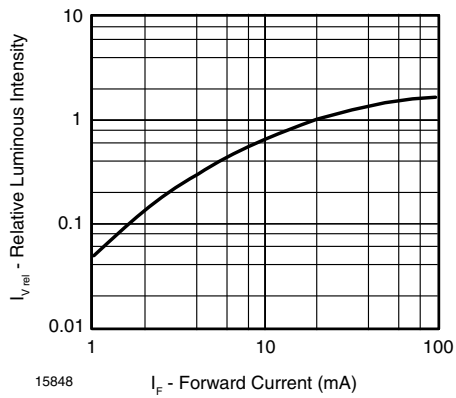
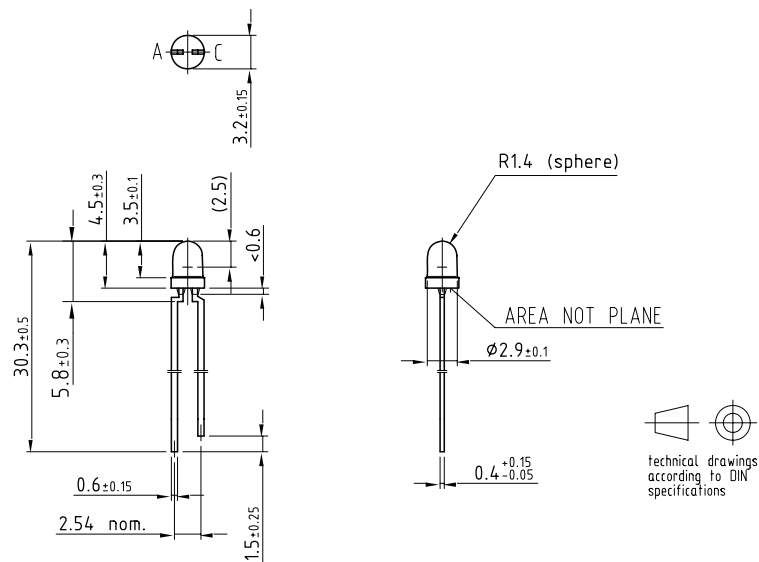

Figure 6. Relative Luminous Flux vs. Forward Current

PACKAGE DIMENSIONS in millimeters



Drawing-No.: 6.544-5255.01-4
Issue: 5; 08.11.99
95 10913